

Product Specification

Description	LED Amusement Lamp
Model NO	YJLED-019-S8RGB

Product Picture

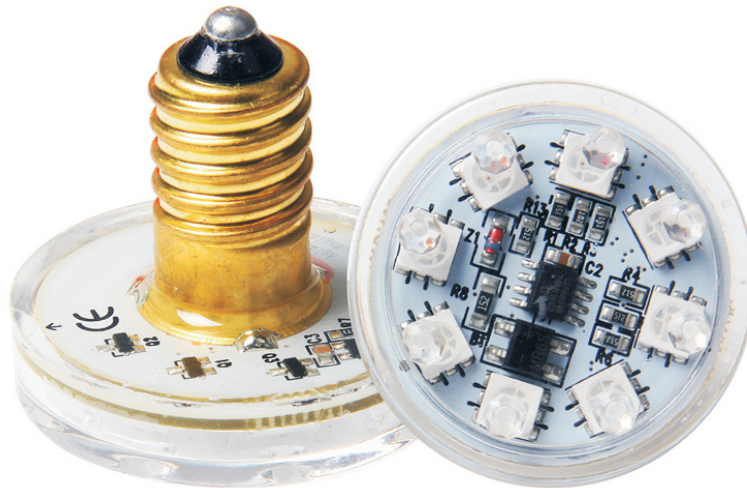

Ip44 CE RoHS

Product Application



Amusement LED Lamps are widely used in the park, Theme park, amusement park and all kinds of amusement machines



SHENZHEN AGLARE LIGHTING CO., LTD
Web: www.aglare.cn / www.amusementlamp.com
Email: aglare@aglare.cn
Tel: +86-75588868631

Product Structure

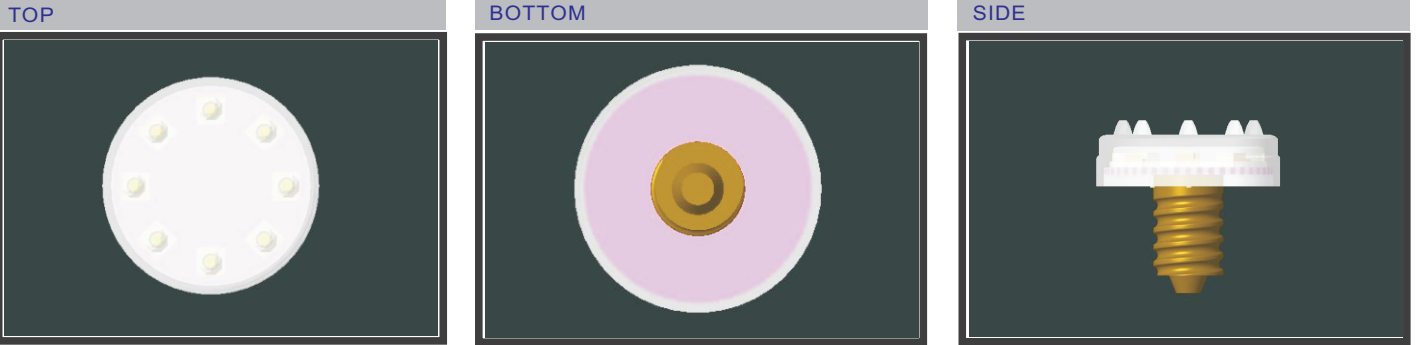

Product Material

Product size

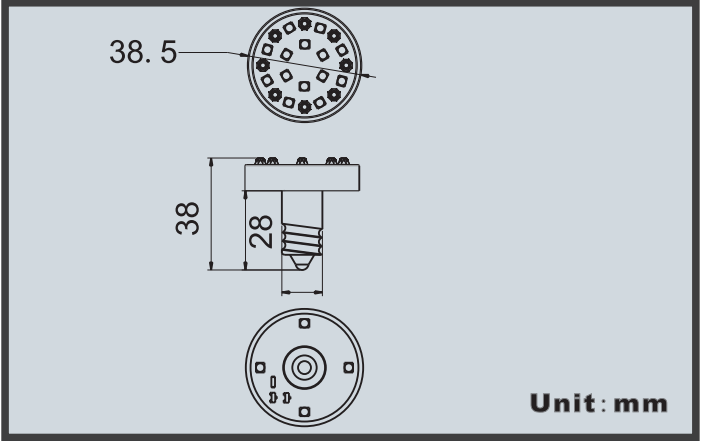
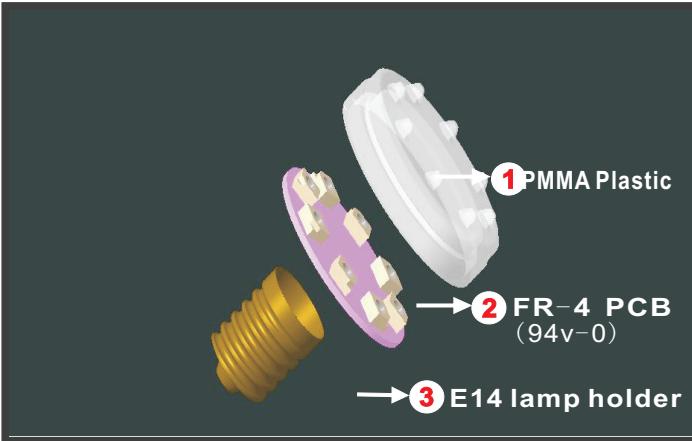

Product Parameters

Part No.	Voltage	Color	Watts	LEDs	IP	Beam angle	Weight
YJLED-019-S8RGB	AC60V		max1.6W	8pcs 5050	Ip44	120°	13.2g

R: 625-630nm G: 520-525nm B: 465-470nm Y: 585-595nm O: 600-605nm P: 390-410nm

Product Installation

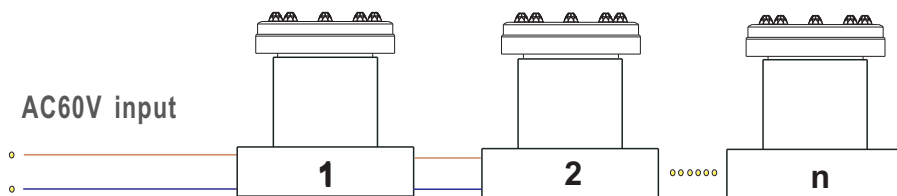

Note:

- 1 The power supply output is AC60v.
- 2 The main wire per square mm up to 10A current
- 3 The distance between the controller and the lamp or the lamp and the lamp must be less than 5 meters, Otherwise you need to connect the signal amplifier
- 4 Please note that the signal line and high voltage line separation



SHENZHEN AGLARE LIGHTING CO., LTD
 Web: www.aglare.cn / www.amusementlamp.com
 Email: aglare@aglare.cn
 Tel: +86-75588868631

Product Package

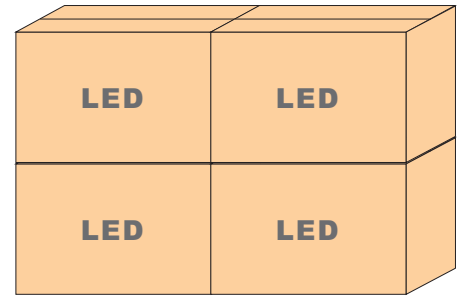
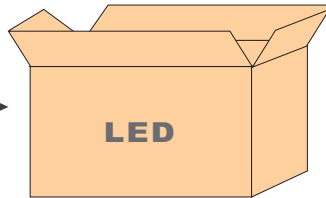
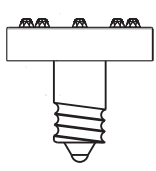

WEIGHT/PCS	Box Size	G. W	PCS/CARTON	CARTON SIZE
13.2g	28*28*16cm	11.6g	702pcs	60*30*35cm

Instructions :

K=K Material Carton
Electrostatic bag

Caution

Please read the specification before used :

Working temperature range -25°C - 45°C

Working voltage range less than $\pm 10\%$

Please turn off the power before installation

