



Specification For Approval

Customer: _____
Product: _____
Part No. : YJ-S5050R6
Ref. No: _____
Date: 2009-09-12

Made by Shenzhen Aglare Lighting Co. Ltd

Production Dept	Q.C. Dept	Engineering Dept	Marketing Dept
Wen Liu	Fang Yang	Jiang Yang	Fang Wang

Approved by

Engineering Dept	Production Dept	Q.C. Dept	Manager



1. P/N: YJ-S5050R6

2. Package Dimensions (mm)

Tolerance: $\pm 0.25(0.01)$

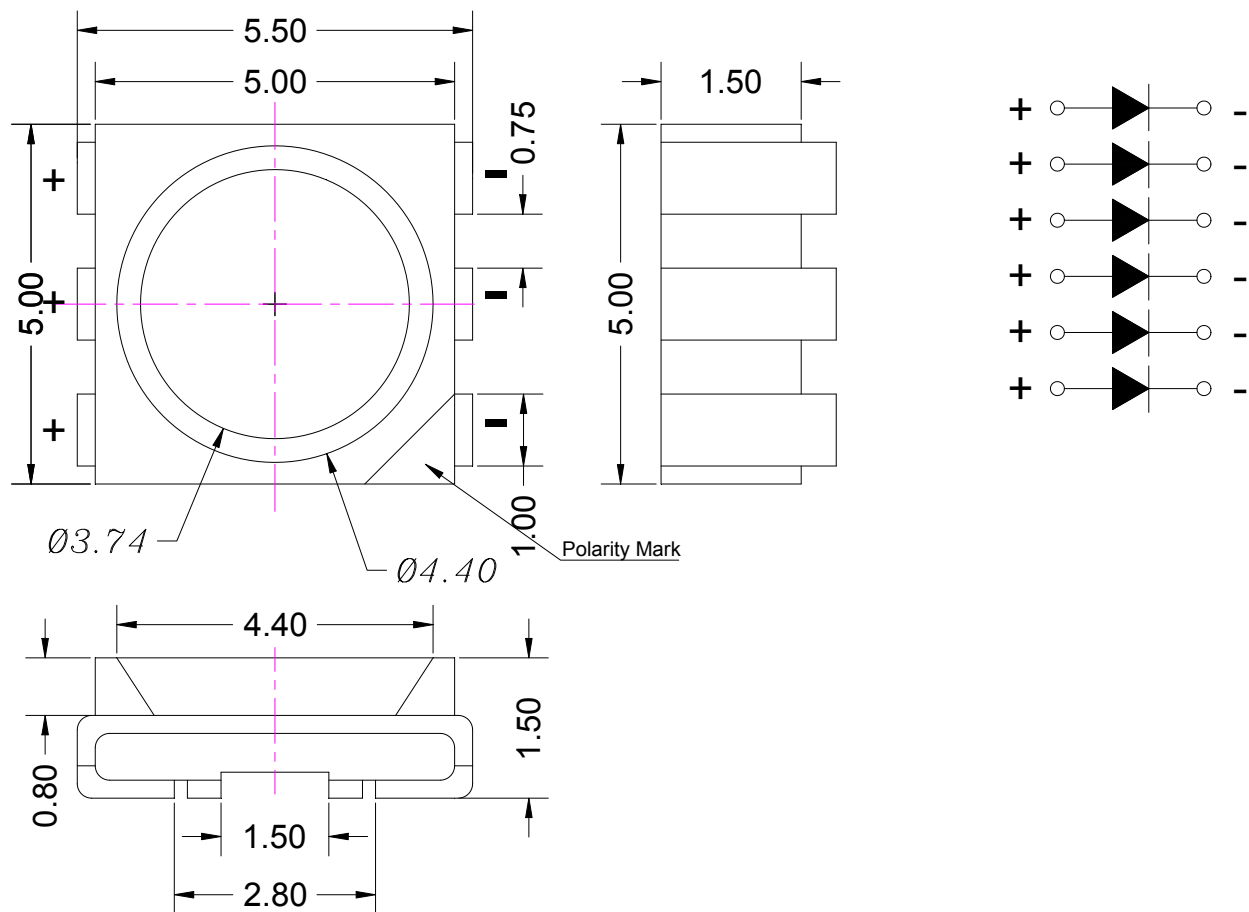

Unit: mm

Color: RED

Lens-color: Water clear

Emitting Material: AlGaInP

Drawing by: volitation

**3. YJ-S5050R6 Characteristic****LIGHT EMITTING DIODE LAMPS****Absolute maximum ratings****(Ta=25°C)**

	Symbol	Value	Unit
Forward current	If	30	mA
Reverse voltage	Vr	5	V
Power dissipation	Pd	110	mW
Operating temperature range	Top	-25~+80	°C
Storage temperature range	Tstg	-30~+80	°C
Peak pulsing current (1/8 duty f=1KHz)	Ifp	125	mA

Electro-Optical characteristics**(Ta=25°C)**

Parameter	Test Condition	Symbol	Value			Unit
			Min	Typ	Max	
Wavelength at peak emission	If=20mA	peak	620	630	635	nm
Spectral half bandwidth	If=20mA			10		
Forward voltage	If=20mA	Vf	1.8	2.0	2.4	V
Luminous intensity	If=20mA	Iv	1300	1650	2000	mcd



Viewing angle at 50% IV	If=10mA	--	120	--	Deg
Reverse current	Vr=5V	Ir	--	5	μA
Useful life	-	IF=20mA	100000		H

4. Typical electric performance graphs

Typical Electrical/Optical Characteristics Curves
 (Ta=25° Unless Otherwise Noted)

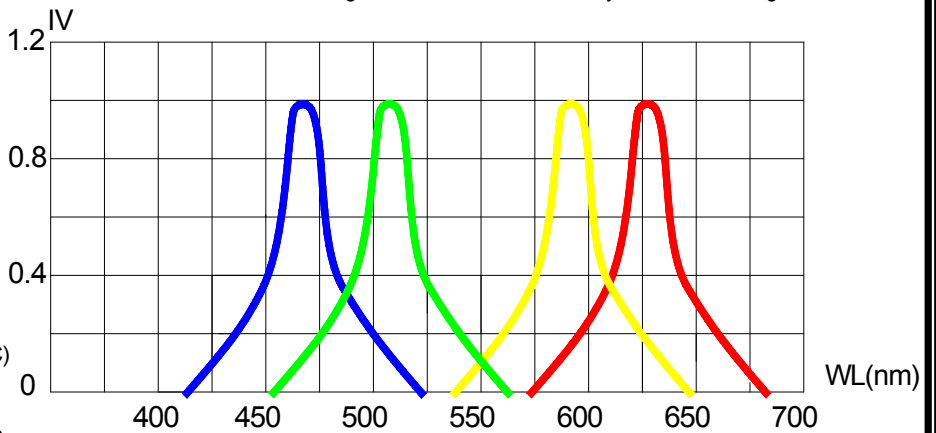
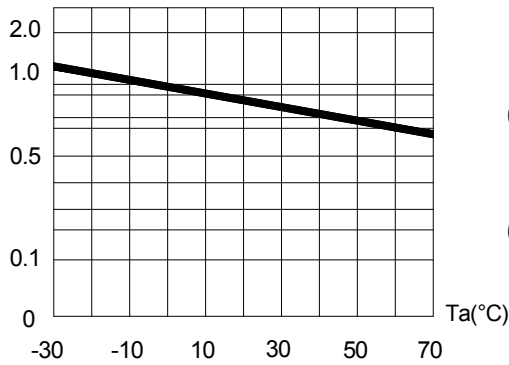
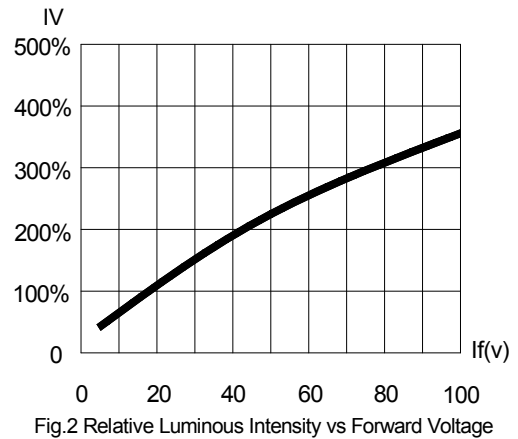
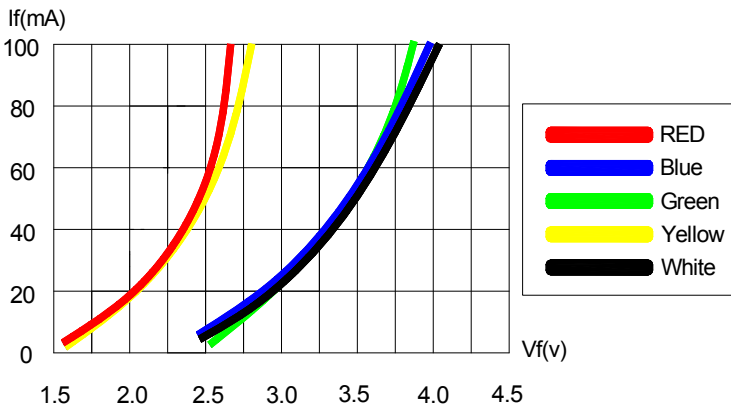
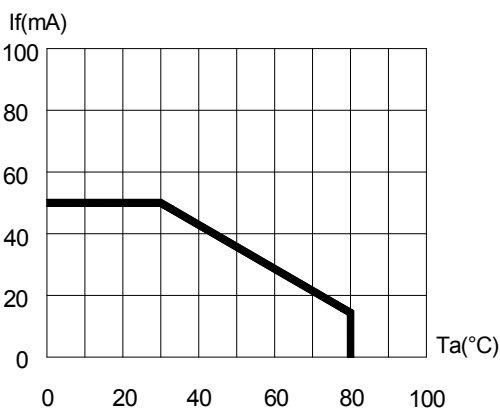

Fig.3 Relative Luminous Intensity vs Ambient Temperature

Fig.4 Relative Luminous Intensity vs Wavelength



Directive Characteristics

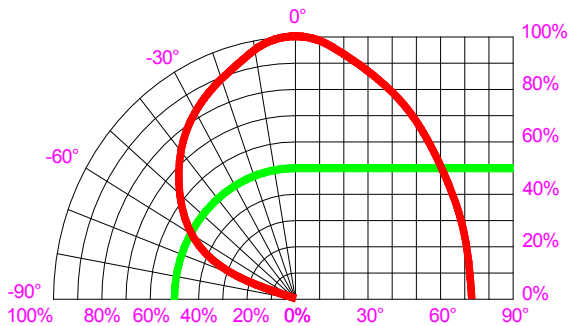

Fig.6 Relative Luminous Intensity vs viewing angle

Fig.5 Maximum Forward Current vs Ambient Temperature



5. Samples test report

No.	Item	Testing conditions	Test cycle	Test samples no.	Ac/Re
1	Tin-plated test	Temp: 260°C±5°C	5 secd.	76 PCS	0/1
2	Back & forth test under high & low temp at intervals	High temp.: +85°C30min to 5min to -55°C30min	50 bout	76 PCS	0/1
3	Heat pounding test	High emp. : +100°C30min To 10sec to -10°C30min	50 bout	76 PCS	0/1
4	High storage temp.	Temperature: 100°C	1000 Hr.	76 PCS	0/1
5	Low storage temp.	-55°C	1000 Hr.	76 PCS	0/1
6	Life span test	VF=1.9V IF=20mA	1000 Hr.	76 PCS	0/1
7	Test under high temp.& high Humidity	85°C/85%RH	1000 Hr.	76 PCS	0/1

6. Points For Attention

(I) SOLDER CONDITIONS

i Iron Soldering: the Iron (max 30W) end temperature less than 300°C, soldering time≤3 seconds, soldering position is minim 2mm from body.

ii Dip Soldering: Max temperature is 260°C, time ≤5, the position is minim 2mm from body.

(II) PIN MOULDING METHOD

i Bracket must be bent only if 2mm from colloid.

ii Bracket mould must be finished by fixture or professionals.

iii Bracket mould must be finished before soldering.

iv Bracket mould should assure the consistent between the pin, the distance gap of leads and the circuit board.

(III)LED ASSEMBLY METHOD

i. It should be pay attention to the ordering of all the devices in case of wrong polarity. Devices can't be too close to the heat components, working conditions can't surpass the limits.

ii. It should not assemble LED when the leads are deformed.

iii. When decide to assemble in holes, accurately account the sizes of holes and holes distance of the line base

iv. Suggest using guard sheath positioning

v. It should avoid any kinds of quake or force on LED, before the soldering temperature returns normal.

(IV) CLEANING

It should be very cautious. When clean the body with chemicals. Some chemicals may bring damages to the surface, and bring color fading, such as, Trichloroethylene, Acetone. Should use ethanol to wipe, dip for no more than 3 minutes under the normal temperature



7. Packing Specification

